

Aluminium V pulleys
Different types
Poulies trapézoïdales aluminium
Les différents types

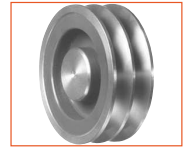

Les poulies présentées sur cette page sont en **alliage d'aluminium**. Elles sont **très compétitives à l'achat**, et leur faible inertie permet, à l'usage, **une économie d'énergie**.
Nous sommes équipés pour réaliser dans les meilleurs délais toute poulie **suivant vos plans**, ainsi que les traitements de surface. Notre usine est également à votre disposition pour tout **alésage, rainurage et vis de pression, équilibrage, etc...**

Type 1

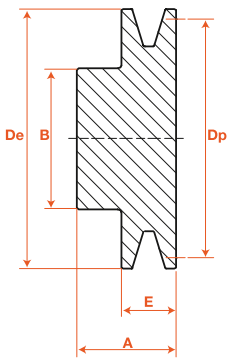

Type 2

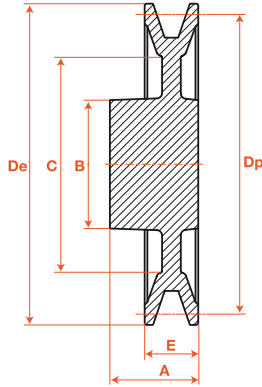

Type 3

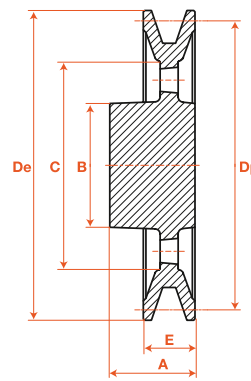

Type 4

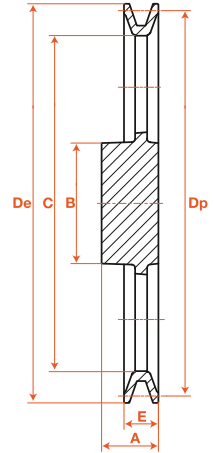

Type 5

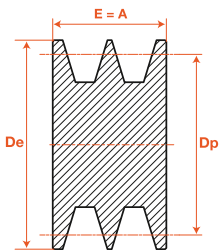

Type 6

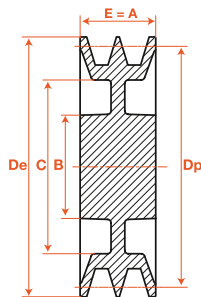

Type 7

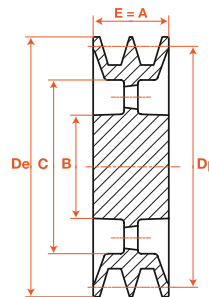

Type 8

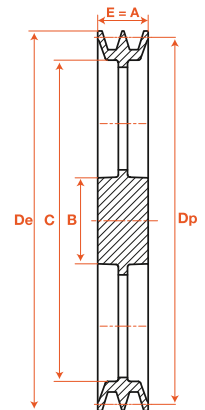

Type 9

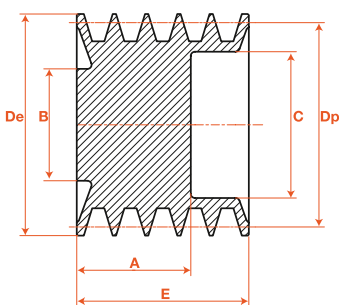

Type 10

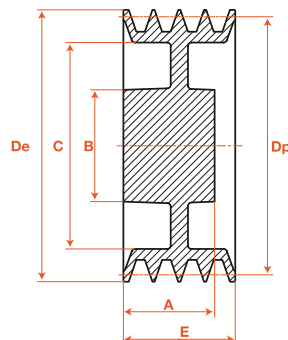

Type 11

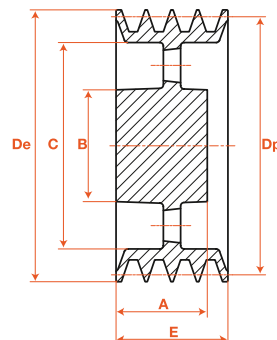

Type 12

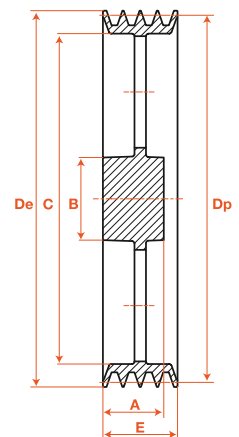

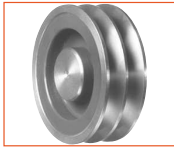

Aluminium V pulleys Z, SPZ or XPZ profil Poulies trapézoïdales aluminium



The pulleys featured on this page are of *aluminium alloy*. They have very *competitive prices*, and low inertia enables *energy savings*.

We are equipped to make pulleys to *your design*, as well as *surface treatment*.

Our factory is at your disposal for all *re-bore*, *keyway*, *threads for tightening screws*, *balancing*, etc...

STOCK AND PRICES
ON ITAFRAN.COM

Dp mm	Z											
	1 gorge - A=29 - E=16				2 gorges - A=36 - E=28				3 gorges - A=40 - E=40			
	Code	Type	B mm	Masse kg	Code	Type	B mm	Masse kg	Code	Type	B mm	Masse kg
40	PAZ1040	A1	29	0,07	PAZ2040	A1	29	0,10	PAZ3040	A5	--	0,12
45	PAZ1045	A1	35	0,10	PAZ2045	A1	33	0,16	PAZ3045	A5	--	0,17
50	PAZ1050	A1	35	0,13	PAZ2050	A1	33	0,15	PAZ3050	A5	--	0,18
55	PAZ1055	A1	41	0,14	PAZ2055	A1	39	0,22	PAZ3050	A5	--	0,18
60	PAZ1060	A1	41	0,17	PAZ2060	A1	39	0,22	PAZ3060	A5	--	0,27
63	PAZ1063	A1	41	0,17	PAZ2063	A1	41	0,20	PAZ3063	A5	--	--
65	PAZ1065	A1	41	0,17	PAZ2065	A1	41	0,20	PAZ3065	A5	--	--
70	PAZ1070	A1	41	0,20	PAZ2070	A1	41	0,29	PAZ3070	A5	--	0,39
75	PAZ1075	A2	42	0,18	PAZ2075	A2	42	0,32	PAZ3075	A6	46	0,37
80	PAZ1080	A2	42	0,20	PAZ2080	A2	42	0,32	PAZ3080	A6	46	0,42
85	PAZ1085	A2	45	0,23	PAZ2085	A2	45	0,39	PAZ3085	A6	46	0,54
90	PAZ1090	A2	45	0,27	PAZ2090	A2	45	0,39	PAZ3090	A6	46	0,53
95	PAZ1095	A2	48	0,35	PAZ2095	A2	45	0,48	PAZ3095	A6	46	0,53
100	PAZ1100	A2	48	0,35	PAZ2100	A2	45	0,42	PAZ3100	A6	46	0,60
106	PAZ1106	A2	48	--	PAZ2106	A3	45	--	PAZ3106	A6	48	--
110	PAZ1110	A2	48	0,38	PAZ2110	A3	45	0,45	PAZ3110	A6	48	0,65
112	PAZ1112	A2	48	0,37	PAZ2112	A3	45	0,50	PAZ3112	A6	48	--
118	PAZ1118	A3	48	0,38	PAZ2118	A3	46	0,50	PAZ3118	A6	51	--
120	PAZ1120	A3	48	0,40	PAZ2120	A3	46	0,50	PAZ3120	A6	51	0,75
125	PAZ1125	A3	50	0,40	PAZ2125	A3	46	0,47	PAZ3125	A6	53	0,83
130	PAZ1130	A3	50	0,45	PAZ2130	A3	46	0,55	PAZ3130	A6	53	0,79
140	PAZ1140	A3	54	0,52	PAZ2140	A3	51	0,60	PAZ3140	A7	55	0,90
150	PAZ1150	A3	55	0,55	PAZ2150	A3	51	0,65	PAZ3150	A7	55	0,97
160	PAZ1160	A3	56	0,60	PAZ2160	A3	51	0,73	PAZ3160	A7	57	1,08
170	PAZ1170	A3	57	0,66	PAZ2170	A3	51	0,73	PAZ3170	A7	58	1,18
180	PAZ1180	A3	57	0,72	PAZ2180	A3	51	0,86	PAZ3180	A7	59	1,25
190	PAZ1190	A3	58	0,80	PAZ2190	A3	53	0,87	PAZ3190	A7	60	1,45
200	PAZ1200	A3	60	0,79	PAZ2200	A3	55	0,95	PAZ3200	A7	60	1,36
210	PAZ1210	A3	60	0,85	PAZ2210	A3	55	1,05	PAZ3210	A7	62	1,45
220	PAZ1220	A3	60	0,94	PAZ2220	A3	60	1,05	PAZ3220	A7	62	1,73
224	PAZ1224	A4	60	0,73	PAZ2224	A4	60	--	PAZ3224	A8	52	--
230	PAZ1230	A4	60	0,80	PAZ2230	A4	60	1,17	PAZ3230	A8	62	1,70
240	PAZ1240	A4	60	0,75	PAZ2240	A4	60	1,11	PAZ3240	A8	62	1,80
250	PAZ1250	A4	60	0,92	PAZ2250	A4	65	1,25	PAZ3250	A8	62	1,83
280	PAZ1280	A4	64	1,00	PAZ2280	A4	65	1,53	PAZ3280	A8	65	2,18
300	PAZ1300	A4	66	1,13	PAZ2300	A4	68	1,43	PAZ3300	A8	68	2,20
320	PAZ1320	A4	70	1,23	PAZ2320	A4	70	1,90	PAZ3320	A8	74	2,60
350	PAZ1350	A4	75	1,40	PAZ2350	A4	75	2,30	PAZ3350	A8	76	2,80
400	PAZ1400	A4	80	1,80	PAZ2400	A4	82	2,60	PAZ3400	A8	80	--
450	PAZ1450	A4	83	2,10	PAZ2450	A4	85	2,87	PAZ3450	A8	85	4,25
500	PAZ1500	A4	85	2,85	PAZ2500	A4	88	3,60	PAZ3500	A8	88	4,82

Belts, Pulleys

4

 Toutes réalisations sur plan,
matériaux et traitements divers : **section 1**

 All machining to drawings,
Special material and treatments : **1st section**



Aluminium V pulleys A, SPA or XPA profil Poulies trapézoïdales aluminium

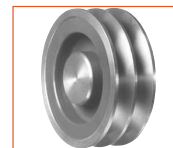

STOCK ET PRIX
SUR ITAFRAN.COM

Les poulies présentées sur cette page sont en **alliage d'aluminium**. Elles sont **très compétitives à l'achat**, et leur faible inertie permet, à l'usage, **une économie d'énergie**.
Nous sommes équipés pour réaliser dans les meilleurs délais toute poulie **suivant vos plans**, ainsi que les traitements de surface. Notre usine est également à votre disposition pour tout **alésage, rainurage et vis de pression, équilibrage, etc...**

A												
Dp mm	1 gorge - A=33 - E=20				2 gorges - A=43 - E=35				3 gorges - A=50 - E=50			
	Code	Type	B mm	Masse kg	Code	Type	B mm	Masse kg	Code	Type	B mm	Masse kg
40	PAA1040	A1	29	0,10	PAA2040	A1	29	0,13	PAA3040	A5	--	0,15
45	PAA1045	A1	35	0,14	PAA2045	A1	35	0,18	PAA3045	A5	--	0,24
50	PAA1050	A1	35	0,14	PAA2050	A1	35	0,18	PAA3050	A5	--	0,22
55	PAA1055	A1	40	0,19	PAA2055	A1	40	0,22	PAA3055	A5	--	0,26
60	PAA1060	A1	40	0,19	PAA2060	A1	40	0,26	PAA3060	A5	--	0,32
63	PAA1063	A1	41	0,19	PAA2063	A1	41	0,28	PAA3063	A5	--	0,36
70	PAA1070	A2	41	0,22	PAA2070	A2	42	0,32	PAA3070	A5	--	0,44
75	PAA1075	A2	42	0,21	PAA2075	A2	46	0,36	PAA3075	A6	48	0,47
80	PAA1080	A2	42	0,24	PAA2080	A2	46	0,41	PAA3080	A6	48	0,54
85	PAA1085	A2	42	0,25	PAA2085	A2	46	0,40	PAA3085	A6	48	0,60
90	PAA1090	A2	46	0,30	PAA2090	A2	46	0,47	PAA3090	A6	48	0,66
95	PAA1095	A2	48	0,36	PAA2095	A2	48	0,54	PAA3095	A6	48	0,80
100	PAA1100	A2	48	0,36	PAA2100	A2	48	0,55	PAA3100	A6	48	0,80
106	PAA1106	A2	48	0,35	PAA2106	A2	48	0,59	PAA3106	A6	48	--
110	PAA1110	A2	48	0,38	PAA2110	A2	48	0,62	PAA3110	A6	48	0,78
112	PAA1112	A2	48	0,40	PAA2112	A2	48	0,66	PAA3112	A6	48	0,82
118	PAA1118	A3	48	0,42	PAA2118	A3	48	0,57	PAA3118	A6	51	--
120	PAA1120	A3	48	0,43	PAA2120	A3	48	0,65	PAA3120	A6	51	0,86
125	PAA1125	A3	50	0,42	PAA2125	A3	51	0,63	PAA3125	A6	51	0,86
130	PAA1130	A3	50	0,46	PAA2130	A3	51	0,72	PAA3130	A6	51	0,99
140	PAA1140	A3	54	0,57	PAA2140	A3	55	0,75	PAA3140	A7	55	1,10
150	PAA1150	A3	55	0,60	PAA2150	A3	55	0,89	PAA3150	A7	59	1,25
160	PAA1160	A3	56	0,66	PAA2160	A3	58	0,90	PAA3160	A7	60	1,35
170	PAA1170	A3	57	0,72	PAA2170	A3	58	1,07	PAA3170	A7	60	1,38
180	PAA1180	A3	58	0,75	PAA2180	A3	60	1,10	PAA3180	A7	62	1,53
190	PAA1190	A3	58	0,85	PAA2190	A3	60	1,21	PAA3190	A7	62	1,55
200	PAA1200	A3	60	0,89	PAA2200	A3	62	1,38	PAA3200	A7	62	1,75
210	PAA1210	A3	60	0,89	PAA2210	A3	62	1,30	PAA3210	A7	62	1,75
220	PAA1220	A3	60	1,05	PAA2220	A3	62	1,46	PAA3220	A7	62	1,85
224	PAA1224	A4	60	0,80	PAA2224	A4	62	1,30	PAA3224	A8	62	1,65
230	PAA1230	A4	60	0,90	PAA2230	A4	62	1,50	PAA3230	A8	62	1,90
240	PAA1240	A4	60	0,82	PAA2240	A4	62	1,30	PAA3240	A8	62	2,00
250	PAA1250	A4	60	0,95	PAA2250	A4	62	1,45	PAA3250	A8	62	1,95
280	PAA1280	A4	64	1,10	PAA2280	A4	64	1,70	PAA3280	A8	65	2,30
300	PAA1300	A4	66	1,20	PAA2300	A4	69	1,80	PAA3300	A8	68	2,55
320	PAA1320	A4	70	1,32	PAA2320	A4	70	2,00	PAA3320	A8	74	2,87
350	PAA1350	A4	75	1,45	PAA2350	A4	76	2,30	PAA3350	A8	76	3,04
400	PAA1400	A4	80	1,90	PAA2400	A4	82	3,00	PAA3400	A8	82	3,76
450	PAA1450	A4	83	2,20	PAA2450	A4	85	3,55	PAA3450	A8	85	4,89
500	PAA1500	A4	92	2,50	PAA2500	A4	88	4,15	PAA3500	A8	93	5,10



Toutes réalisations sur plan,
matériaux et traitements divers : **section 1**

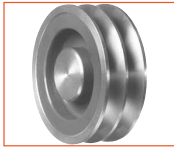

Aluminium V pulleys A, SPA or XPA profil Poulies trapézoïdales aluminium



The pulleys featured on this page are of *aluminium alloy*. They have very *competitive prices*, and low inertia enables *energy savings*.

We are equipped to make pulleys to *your design*, as well as *surface treatment*.

Our factory is at your disposal for all *re-bore, keyway, threads for tightening screws, balancing, etc...*

STOCK AND PRICES
ON ITAFRAN.COM

A								
Dp mm	4 gorges - A=53/65 - E=65				5 gorges - A=53/80 - E=80			
	Code	Type	B mm	Masse kg	Code	Type	B mm	Masse kg
40	PAA4040	A5	-	--	PAA5040	A5	-	--
45	PAA4045	A5	-	--	PAA5045	A5	-	--
50	PAA4050	A5	-	--	PAA5050	A5	-	0,34
55	PAA4055	A5	-	--	PAA5055	A5	-	--
60	PAA4060	A5	-	0,40	PAA5060	A5	-	0,51
63	PAA4063	A5	-	--	PAA5063	A5	-	--
70	PAA4070	A5	-	0,57	PAA5070	A5	-	--
75	PAA4075	A6	48	0,77	PAA5075	A5	-	--
80	PAA4080	A6	48	0,70	PAA5080	A9	48	0,75
85	PAA4085	A6	48	0,82	PAA5085	A9	48	--
90	PAA4090	A6	48	0,82	PAA5090	A9	48	1,00
95	PAA4095	A10	52	0,92	PAA5095	A9	52	--
100	PAA4100	A10	52	0,91	PAA5100	A10	52	1,27
106	PAA4106	A10	54	--	PAA5106	A10	52	--
110	PAA4110	A10	54	0,97	PAA5110	A10	52	1,51
112	PAA4112	A10	54	--	PAA5112	A10	52	--
118	PAA4118	A10	56	--	PAA5118	A10	60	--
120	PAA4120	A10	56	1,15	PAA5120	A10	60	1,40
125	PAA4125	A10	56	1,27	PAA5125	A10	60	--
130	PAA4130	A10	56	1,30	PAA5130	A10	60	1,55
140	PAA4140	A10	58	1,38	PAA5140	A10	62	1,67
150	PAA4150	A10	65	1,50	PAA5150	A10	65	1,90
160	PAA4160	A11	68	1,70	PAA5160	A10	68	2,06
170	PAA4170	A11	68	1,95	PAA5170	A10	70	2,25
180	PAA4180	A11	68	1,90	PAA5180	A10	70	2,00
190	PAA4190	A11	68	2,05	PAA5190	A11	70	2,34
200	PAA4200	A11	68	2,25	PAA5200	A11	74	2,89
210	PAA4210	A11	68	2,30	PAA5210	A11	74	--
220	PAA4220	A11	68	2,44	PAA5220	A11	74	--
224	PAA4224	A12	68	--	PAA5224	A12	74	--
230	PAA4230	A12	68	2,52	PAA5230	A12	74	--
240	PAA4240	A12	68	2,40	PAA5240	A12	74	--
250	PAA4250	A12	68	2,68	PAA5250	A12	74	--
280	PAA4280	A12	68	2,80	PAA5280	A12	78	4,10
300	PAA4300	A12	70	3,22	PAA5300	A12	78	4,35
320	PAA4320	A12	72	3,25	PAA5320	A12	78	5,23
350	PAA4350	A12	76	4,35	PAA5350	A12	85	6,10
400	PAA4400	A12	89	5,15	PAA5400	A12	85	6,19
450	PAA4450	A12	85	5,90	PAA5450	A12	85	6,66
500	PAA4500	A12	88	6,00	PAA5500	A12	88	7,50



All machining to drawings,
Special material and treatments : **1st section**



Aluminium V pulleys B, SPB or XPB profil Poulies trapézoïdales aluminium



STOCK ET PRIX
SUR ITAFRAN.COM

Les poulies présentées sur cette page sont en **alliage d'aluminium**. Elles sont **très compétitives à l'achat**, et leur faible inertie permet, à l'usage, **une économie d'énergie**.
Nous sommes équipés pour réaliser dans les meilleurs délais toute poulie **suivant vos plans**, ainsi que les traitements de surface. Notre usine est également à votre disposition pour tout **alésage, rainurage et vis de pression, équilibrage, etc...**

Dp mm	B											
	1 gorge - A=39 - E=25				2 gorges - A=44 - E=44				3 gorges - A=63 - E=63			
	Code	Type	B mm	Masse kg	Code	Type	B mm	Masse kg	Code	Type	B mm	Masse kg
50	PAB1050	A1	36	0,17	PAB2050	A5	-	0,18	--	--	--	--
55	PAB1055	A1	42	0,29	PAB2055	A5	-	--	--	--	--	--
60	PAB1060	A1	42	0,32	PAB2060	A5	-	0,29	PAB3060	A5	--	0,40
63	PAB1063	A1	42	--	PAB2063	A5	-	--	PAB3063	A5	--	--
70	PAB1070	A1	42	0,32	PAB2070	A5	-	0,40	PAB3070	A5	--	0,58
75	PAB1075	A2	44	0,28	PAB2075	A6	46	0,59	PAB3075	A6	46	0,72
80	PAB1080	A2	44	0,30	PAB2080	A6	46	0,50	PAB3080	A6	46	0,72
85	PAB1085	A2	48	0,42	PAB2085	A6	46	0,50	PAB3085	A6	46	--
90	PAB1090	A2	48	0,38	PAB2090	A6	46	0,57	PAB3090	A6	46	0,94
95	PAB1095	A2	48	0,45	PAB2095	A6	54	0,83	PAB3095	A6	55	1,11
100	PAB1100	A2	48	0,43	PAB2100	A6	54	0,70	PAB3100	A6	55	1,10
106	PAB1106	A2	48	--	PAB2106	A6	55	--	PAB3106	A6	60	--
110	PAB1110	A2	48	0,44	PAB2110	A6	55	0,86	PAB3110	A6	60	1,25
112	PAB1112	A2	48	0,45	PAB2112	A6	55	0,88	PAB3112	A6	60	--
118	PAB1118	A2	50	--	PAB2118	A6	56	0,88	PAB3118	A6	62	--
120	PAB1120	A2	50	0,53	PAB2120	A6	56	0,90	PAB3120	A6	62	1,30
125	PAB1125	A2	56	0,58	PAB2125	A6	60	0,90	PAB3125	A6	62	1,30
130	PAB1130	A2	56	0,62	PAB2130	A6	60	0,98	PAB3130	A6	62	1,50
140	PAB1140	A2	56	0,62	PAB2140	A6	60	1,09	PAB3140	A6	62	1,60
150	PAB1150	A3	56	0,70	PAB2150	A7	60	1,15	PAB3150	A6	62	1,77
160	PAB1160	A3	56	0,77	PAB2160	A7	62	1,27	PAB3160	A7	62	1,80
170	PAB1170	A3	57	0,80	PAB2170	A7	66	1,38	PAB3170	A7	64	1,99
180	PAB1180	A3	60	0,96	PAB2180	A7	66	1,41	PAB3180	A7	64	2,20
190	PAB1190	A3	62	1,00	PAB2190	A7	68	1,50	PAB3190	A7	70	2,24
200	PAB1200	A3	62	1,00	PAB2200	A7	70	1,65	PAB3200	A7	70	2,52
210	PAB1210	A3	62	1,07	PAB2210	A7	72	1,75	PAB3210	A7	72	2,60
220	PAB1220	A3	64	1,17	PAB2220	A7	72	2,00	PAB3220	A7	72	2,60
224	PAB1224	A4	64	0,95	PAB2224	A8	72	--	PAB3224	A8	72	--
230	PAB1230	A4	64	1,10	PAB2230	A8	72	1,80	PAB3230	A8	72	2,62
240	PAB1240	A4	65	1,20	PAB2240	A8	72	1,95	PAB3240	A8	72	2,80
250	PAB1250	A4	65	1,18	PAB2250	A8	72	2,05	PAB3250	A8	75	2,90
280	PAB1280	A4	74	1,38	PAB2280	A8	72	2,25	PAB3280	A8	75	3,35
300	PAB1300	A4	70	1,50	PAB2300	A8	75	2,49	PAB3300	A8	75	3,45
320	PAB1320	A4	72	1,85	PAB2320	A8	75	2,65	PAB3320	A8	75	3,67
350	PAB1350	A4	75	2,00	PAB2350	A8	75	3,00	PAB3350	A8	78	4,40
400	PAB1400	A4	80	2,35	PAB2400	A8	80	3,50	PAB3400	A8	80	4,86
450	PAB1450	A4	86	2,95	PAB2450	A8	86	4,75	PAB3450	A8	86	5,75
500	PAB1500	A4	88	3,50	PAB2500	A8	93	5,55	PAB3500	A8	86	6,50



Toutes réalisations sur plan,
matériaux et traitements divers : **section 1**



Aluminium V pulleys B, SPB or XPB profil Poulies trapézoïdales aluminium



The pulleys featured on this page are of *aluminium alloy*. They have very *competitive prices*, and low inertia enables *energy savings*.

We are equipped to make pulleys to *your design*, as well as *surface treatment*.

Our factory is at your disposal for all *re-bore, keyway, threads for tightening screws, balancing, etc...*

STOCK AND PRICES
ON ITAFRAN.COM

B								
Dp mm	4 gorges - A=65/82 - E=82				5 gorges - A=73/82 - E=101			
	Code	type	B mm	Masse kg	Code	type	B mm	Masse kg
80	PAB4080	A5	55	1,04	--	--	--	--
85	PAB4085	A5	47	1,18	--	--	--	--
90	PAB4090	A5	47	1,18	--	--	--	--
95	PAB4095	A9	55	--	--	--	--	--
100	PAB4100	A9	55	1,31	PAB5100	A9	55	1,65
106	PAB4106	A10	60	--	PAB5106	A10	60	--
110	PAB4110	A10	60	1,45	PAB5110	A10	60	1,90
112	PAB4112	A10	60	--	PAB5112	A10	60	--
118	PAB4118	A10	66	--	PAB5118	A10	64	--
120	PAB4120	A10	66	1,70	PAB5120	A10	64	1,90
125	PAB4125	A10	66	1,80	PAB5125	A10	66	--
130	PAB4130	A10	66	1,80	PAB5130	A10	66	2,17
140	PAB4140	A10	66	1,86	PAB5140	A10	70	2,28
150	PAB4150	A10	68	2,15	PAB5150	A10	72	2,55
160	PAB4160	A10	70	2,00	PAB5160	A10	72	2,87
170	PAB4170	A10	70	2,00	PAB5170	A10	74	3,06
180	PAB4180	A11	70	2,55	PAB5180	A10	74	3,30
190	PAB4190	A11	72	2,95	PAB5190	A11	75	3,50
200	PAB4200	A11	72	3,12	PAB5200	A11	75	3,65
210	PAB4210	A11	72	3,30	PAB5210	A11	78	3,90
220	PAB4220	A11	72	3,25	PAB5220	A11	78	--
224	PAB4224	A12	74	--	PAB5224	A12	78	--
230	PAB4230	A12	74	3,36	PAB5230	A12	78	--
240	PAB4240	A12	78	3,55	PAB5240	A12	78	4,33
250	PAB4250	A12	78	3,65	PAB5250	A12	78	--
280	PAB4280	A12	78	4,27	PAB5280	A12	78	4,75
300	PAB4300	A12	82	4,50	PAB5300	A12	82	5,65
320	PAB4320	A12	84	4,99	PAB5320	A12	86	6,10
350	PAB4350	A12	84	5,70	PAB5350	A12	88	--
400	PAB4400	A12	86	6,00	PAB5400	A12	90	7,25
450	PAB4450	A12	86	6,50	PAB5450	A12	99	--
500	PAB4500	A12	86	7,50	PAB5500	A12	99	--



All machining to drawings,
Special material and treatments : **1st section**

