

DISTRIBUTEURS

3/2 - 5/2 - 5/3

A COMMANDE MUSCULAIRE

G 1/4













| | |
|--------------------------|---|
| Fluides | air ou gaz neutre, filtré, lubrifié ou non |
| Pression d'utilisation | 0 à 10 bar, 2 à 10 bar (pédale) |
| Température ambiante | -25°C à +60°C, -20°C à +60°C (pédale) |
| Débit (Qv à 6 bar) (ANR) | voir tableau de sélection |
| Corps | aluminium anodisé noir, polyéthylène noir (pédale) |
| Capot (pédale) | polyéthylène jaune |
| Pièces internes | zamak, acier inox, POM (polyacétal), aluminium alliage d'aluminium anodisé, acier inox, laiton (pédale) |
| Garnitures | NBR (nitrile) + PUR (polyuréthane) NBR (nitrile) (pédale) |

- Produit fiable et robuste grâce à son corps et à sa commande métalliques
- Alimentation directe de vérin simple et double effet, jusqu'au diamètre 100 mm
- Large plage de températures adaptées aux applications semi-automatisées
- Versions positions maintenues pour la sécurité des machines
- Pédale à large ouverture pour positionner le pied

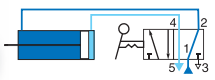
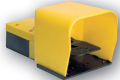
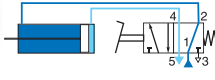
VOTRE SÉLECTION





départ usine **3 jours**

| | débit à 6 bar (ANR) l/min | code | type | dimensions (mm) | | |
|---|---|---------------------------------|------|------------------------|---|--------------|
| | | | | A | B | C |
| 3/2 - commande par levier | | | | | | |
|  |  | levier à 2 positions maintenues | 860 | 55102088 | 1 | 108 112,5 - |
| | | levier-ressort | 860 | 55102089 | 1 | 108 112,5 - |
| 3/2 - commande par bouton | | | | | | |
|  | | bouton ressort | 860 | 55102082 | 4 | voir page 75 |
| | | bouton pousser-tirer | 860 | 55102083 | 4 | |
| 3/2 - commande par pédale | | | | | | |
|  |  | pédale-ressort | 860 | 55102091 | 6 | voir page 75 |
| 5/2 - commande par levier | | | | | | |
|  | | levier à 2 positions maintenues | 860 | 55102092 | 2 | 108 125 - |
| |  | levier à 2 positions maintenues | 1610 | 55200036 | 2 | 108 125 - |
| | | levier-ressort | 860 | 55102093 | 2 | 108 125 - |
| 5/2 - commande par pédale | | | | | | |
|  |  | pédale 2 positions | 860 | 55102094 | 7 | voir page 75 |
|  |  | pédale 2 positions | 655 | ZF2FA400OG00000 | 3 | 145 140 245 |
| | | pédale-ressort | 860 | 55102095 | 7 | voir page 75 |
| 5/2 - commande par bouton | | | | | | |
|  | | bouton pousser-tirer | 860 | 55102086 | 4 | voir page 75 |

DISTRIBUTEURS A COMMANDE MUSCULAIRE

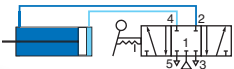
VOTRE SELECTION

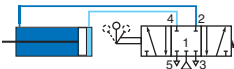
départ usine 3 jours

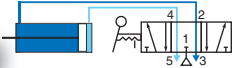
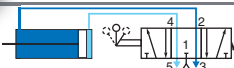
| | débit à 6 bar (ANR) l/min | code | type | dimensions (mm) | | |
|--|--|------|-----------------|-----------------|-----|---------|
| | | | | A | B | C |
| 5/3 - commande par levier - à centre fermé W1 | | | | | | |
|  |  levier à 3 positions maintenues (W1) | 760 | 55102096 | 2 | 108 | - 146,5 |
| |  levier à 3 positions maintenues (W1) | 1610 | 55200038 | 2 | 108 | - 146,5 |
| |  levier à 3 positions, rappel ressort au centre (W1) | 760 | 55102097 | 2 | 108 | - 146,5 |
| |  levier à 3 positions, rappel ressort au centre (W1) | 1610 | 55200039 | 2 | 108 | - 146,5 |
| 5/3 - commande par levier - à centre ouvert échappement W3 | | | | | | |
|  |  levier à 3 positions maintenues (W3) | 760 | 55102098 | 2 | 108 | - 146,5 |
| |  levier à 3 positions, rappel ressort au centre (W3) | 760 | 55102099 | 2 | 108 | - 146,5 |

ENCOMBREMENTS

Type 1

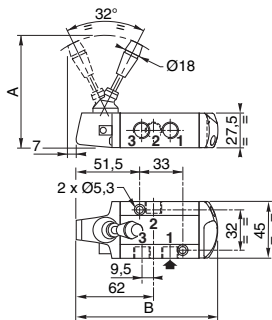

Type 2

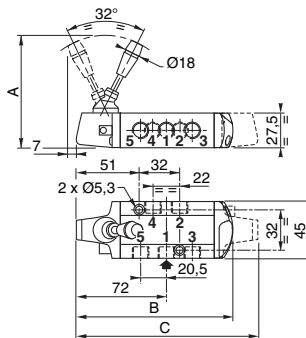

Type 3

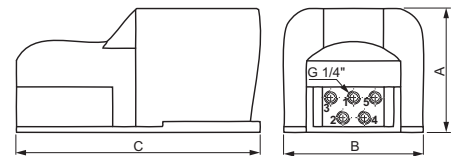

Type 4

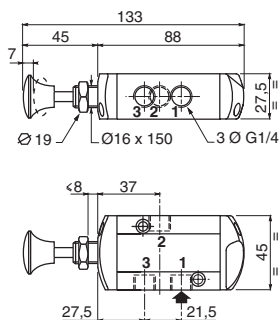

Type 5

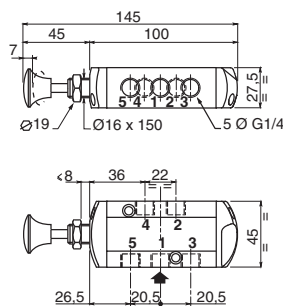

Type 6

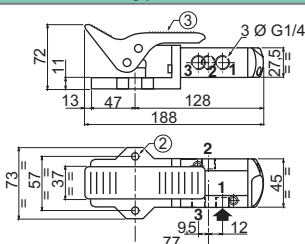

Type 7

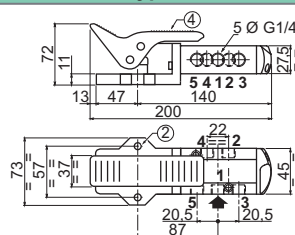

Orifices

- 1 : Pression
- 2-4 : Utilisation
- 3-5 : Echappement