

Tecturis S

Mitigeur de lavabo 150 Fine CoolStart, bonde clic-clac

Finition: **Chrome** Numéro d'article: **73340000**



Description

Caractéristiques

- comprenant: mitigeur de lavabo, garniture de vidage
- ComfortZone: 150
- longueur du bec: 139 mm
- hauteur du bec: 151 mm
- variante de la poignée: poignée goupille
- type de jet: Jet Normal
- débit maximal sous 3 bar de pression: 4 l/min
- cartouche céramique
- convient aux chauffe-eaux instantanés
- garniture de vidage Push-Open G 1 ¼
- matériau de la garniture de vidage: métal
- eau froide en position de poignée centrée
- Taxonomie UE: max. 6 l/min - SC (Substantial Contribution)
- ACS 26 ACC NY 072, valide jusqu'au 09.02.2031

Détails de l'article

EAN

4059625470831

Technologie



Prix de design



Certificats / Eco-Responsabilité



Photo du produit



Plan géométral

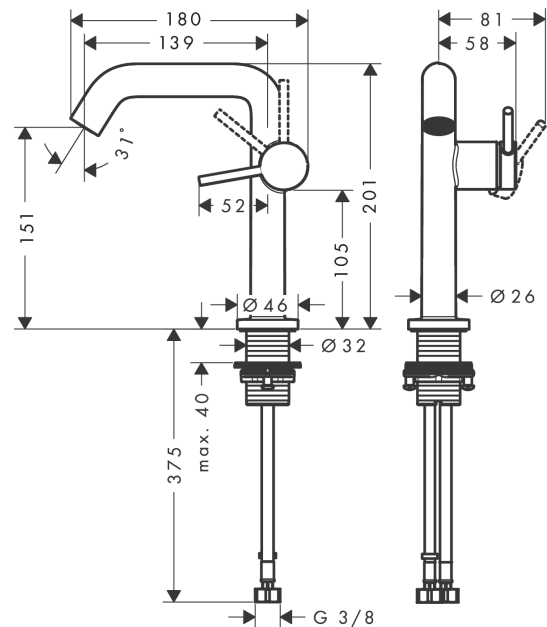

Tecturis S

Mitigeur de lavabo 150 Fine CoolStart, bonde clic-clac

Finition: **Chrome** Numéro d'article: **73340000**



Schéma d'écoulement

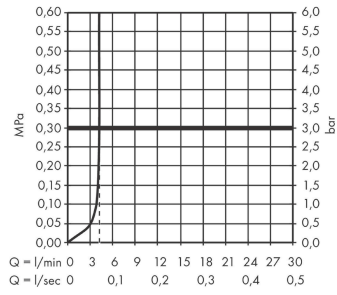

Tecturis S
Mitigeur de lavabo 150 Fine CoolStart, bonde clic-clac
 Finition: **Chrome** Numéro d'article: **73340000**



Vue éclatée

Année de construction: >06/23

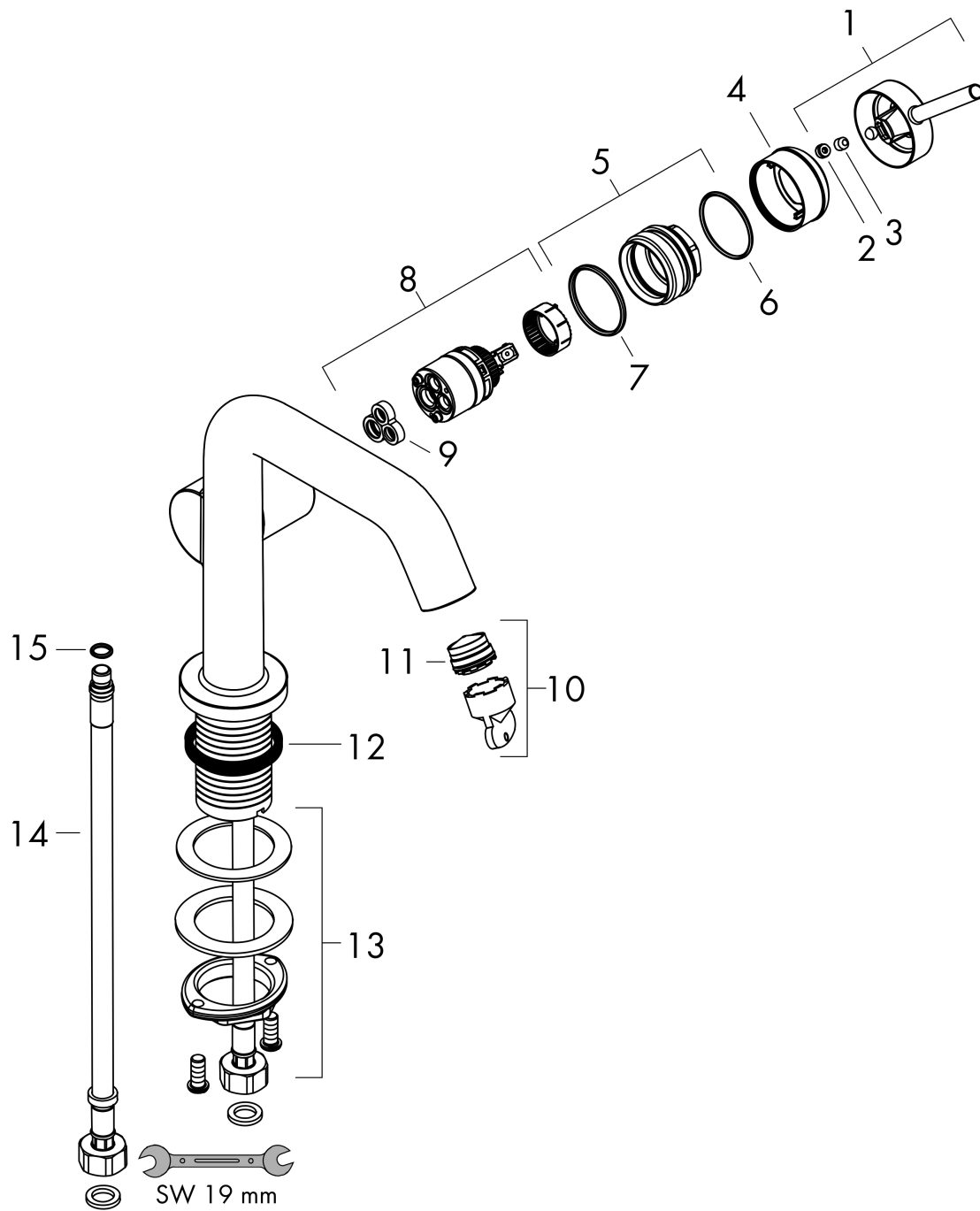

Tecturis S**Mitigeur de lavabo 150 Fine CoolStart, bonde clic-clac**Finition: **Chrome** Numéro d'article: **73340000****Liste des pièces détachées**

Année de construction: >06/23

Pos.	Description	Numéro d'article	GP	UE
1	poignée	94999000	44,62 €	1
2	cache vis	93735460	14,39 €	1
3	vis M5x5	98446000	8,64 €	1
4	rosace	94987000	23,03 €	1
5	écrou à six pans	94989000	14,39 €	1
6	joint torique 28x1,5	98421000	8,64 €	1
7	joint torique 29x2	98391000	8,64 €	1
8	cartouche cpl.	93760000	96,40 €	1
9	joint	93383000	17,27 €	1
10	mousseur	87100000	23,03 €	1
11	clé	93750000	14,39 €	1
12	manchon	98749000	11,51 €	1
13	fixation cpl. (Ø 32)	13961000	28,78 €	1
14	flexible de raccordement 450 mm M8x0,75 G3/8	97206000	34,52 €	1
15	joint torique 6,6x1,6	93019000	8,64 €	1
a	Push-Open synthétique	50100000	-	1
b	rosace inversée	87494000	14,39 €	1