

Tuyaux rigides - Aluminium

→ TUYAU ALUMINIUM

CE 2270-CPR-034

DOP N° TG 01

• EN1856-2-T250-N2-D-Vm - L13050-O (50) M

• EN1856-2-T160-N2-D-Vm - L13050-O (30) M















QUALITÉ A5 99,5

UTILISATION



Raccordement en apparent :

- De générateurs à combustibles Gaz aux conduits de fumées desservants les logements
- Raccordement hotte de cuisine, sèche-linge et chauffe-eau
- Ventilation

PRODUIT	Ø 83	Ø 97	Ø 111	Ø 125	Ø 139	Ø 153	Ø 167	Ø 180	Ø 200	Ø 220
 TUYAU 1000 mm	€ Réf 901830	901970	901111	901125	901139	901153	901167	901180	901200	901220
 TUYAU 660 mm	€ Réf 966830	966970	966111	966125	966139	966153	966167	966180	966200	966220
 TUYAU 500 mm	€ Réf 950830	950970	950111	950125	950139	950153	950167	950180	950200	950220
 TUYAU 330 mm	€ Réf 933830	933970	933111	933125	933139	933153	933167	933180	933200	933220
 COUDE PLISSÉ à 90°	€ Réf 392830	392970	392111	392125	392139	392153	392167	392180	392200	392220
 COUDE PLISSÉ à 72°	€ Réf 393830	393970	393111	393125	393139	393153	393167	393180	393200	393220
 COUDE PLISSÉ à 45°	€ Réf 394830	394970	394111	394125	394139	394153	394167	394180	394200	394220
 COUDE PLISSÉ à 30°	€ Réf 390830	390970	390111	390125	390139	390153	390167	390180	390200	390220
 TÉ ÉQUERRE	€ Réf 694830	694970	694111	694125	694139	694153	694167	694180	694200	694220
 TAMPON ALUMINIUM	€ Réf 109830	109970	109111	109125	109139	109153	109167	109180	109200	109220
 PURGE ALUMINIUM	€ Réf 900830	900970	900111	900125	900139	900153	900167	900180	900200	900220
 ROSACE	€ Réf 790830	790970	790111	790125	790139	790153	790167	790180	790200	790220
 COLLIER DE SUSPENSION	€ Réf 000830	000970	000111	000125	000139	000153	000167	000180	000200	000220
 TUYAU À COLLERETTE	€ Réf 995830	995970	995111	995125	995139	995153	995167	995180	995200	-



RÉDUCTIONS

Ø F x M	Prix €	Réf
97 x 83		599783
111 x 83		591183
111 x 97		591197
125 x 83		592583
125 x 97		592597
125 x 111		592511
139 x 83		593983
139 x 97		593997
139 x 111		593911
139 x 125		593925
153 x 83		595383
153 x 97		595397
153 x 111		595311
153 x 125		595325
153 x 139		595339
167 x 125		596725
167 x 139		596739
167 x 153		596753
180 x 125		598025
180 x 139		598039
180 x 153		598053
180 x 167		598067
200 x 139		590039
200 x 153		590053
200 x 167		590067
200 x 180		590080
220 x 180		592080
220 x 200		592000

ROSACE EXTENSIBLE NICKELÉ

Ø	Prix €	Réf
83 à 139		790001

TAMPON UNIVERSEL

Ø	Prix €	Réf
83 à 139		109001
153 à 200		109002



COUDE 45°

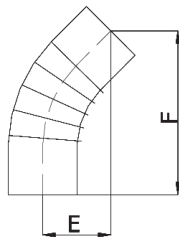

COUDE 72°

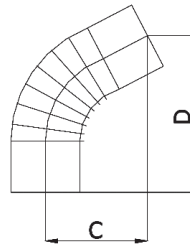

COUDE 90°

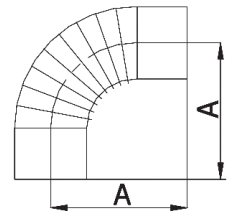

DOUBLE COUDE 45° ET 72°

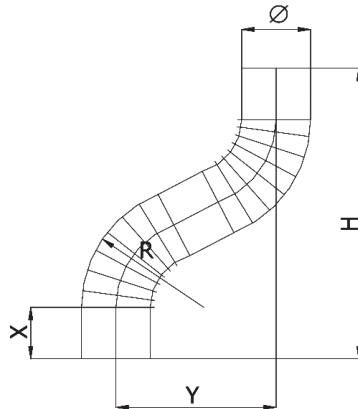

DOUBLE COUDE 90°

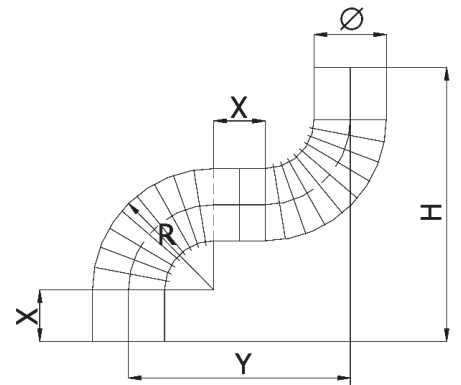

Tableaux de dimensions X = emboîtement de 60 mm

Ø Nom.	COUDE 90°				COUDE 72°					COUDE 45°				
	R	Y	H	A	R	Y	H	C	D	R	Y	H	E	F
83	146	270	329	165	146	201	338	129	178	176	122	352	82	197
97	168	300	359	180	172	228	374	143	196	183	122	352	82	197
111	182	313	373	187	186	237	387	147	203	199	127	365	85	204
125	206	347	407	204	215	268	429	162	224	241	148	414	95	228
139	222	365	425	213	231	280	446	169	232	258	153	429	98	236
153	248	403	463	232	263	315	494	186	256	267	155	431	99	237
167	267	437	507	254	263	315	503	191	262	306	180	505	115	277
180	286	462	532	266	286	338	535	202	278	306	180	496	115	274
200	325	520	590	295	334	390	607	228	314	344	193	535	121	292
220	344	538	608	304	334	377	588	217	303	344	187	521	115	282
250	3P	384	458	229	3P	281	546	166	288	2P	144	408	93	224