

EKHY3PART

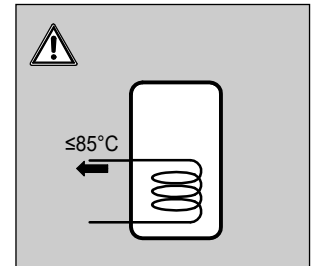

4P376829-1 B 00000006

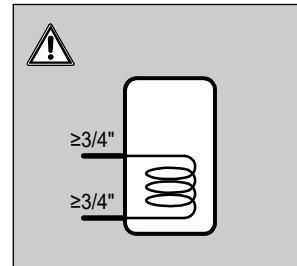
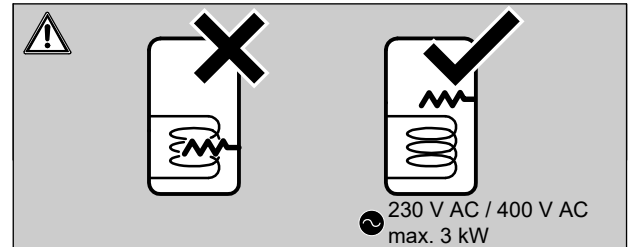
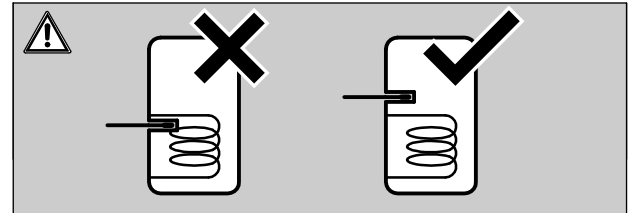
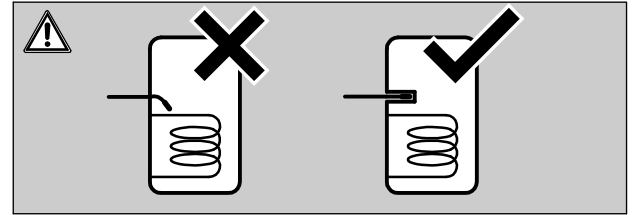
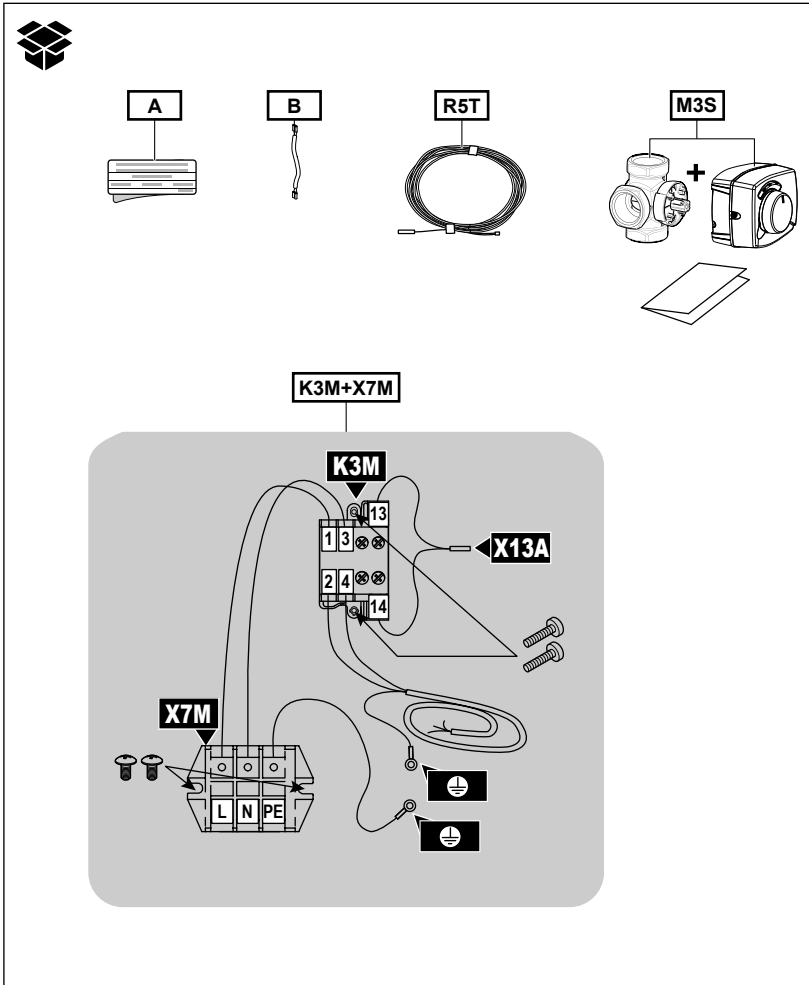

HYHB(H/X)*A

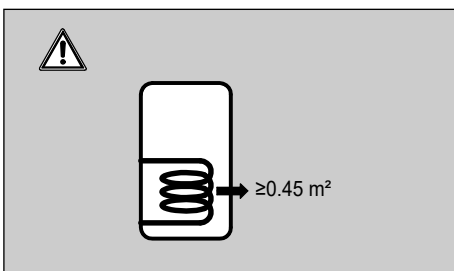

EHB(H/X)*(D/E)* + ETB(H/X)*(D/E)*

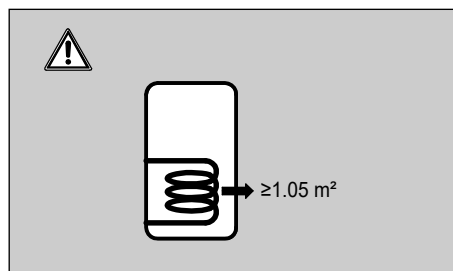

EAB(H/X)*D*

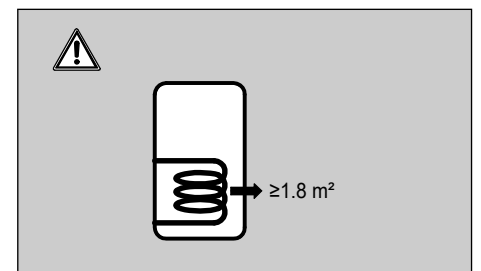

ONLY FOR THE UK

Domestic hot water installations must be installed, commissioned and maintained by a competent person in accordance with Building Regulation G3 (England and Wales), Technical Standard P3 (Scotland) or Building Regulation P5 (Northern Ireland) and the Water Fitting Regulations (England and Wales) or Water Byelaws (Scotland). As such, the installed cylinder must comply with the above mentioned regulations.

To comply, the required safety devices can include, but are not limited to:

- a thermal cut out
- a temperature / pressure relief valve
- a motorised 2-port valve to interrupt the flow in case of high temperature
- other if required according to (local) regulations

HYHB(H/X)*A

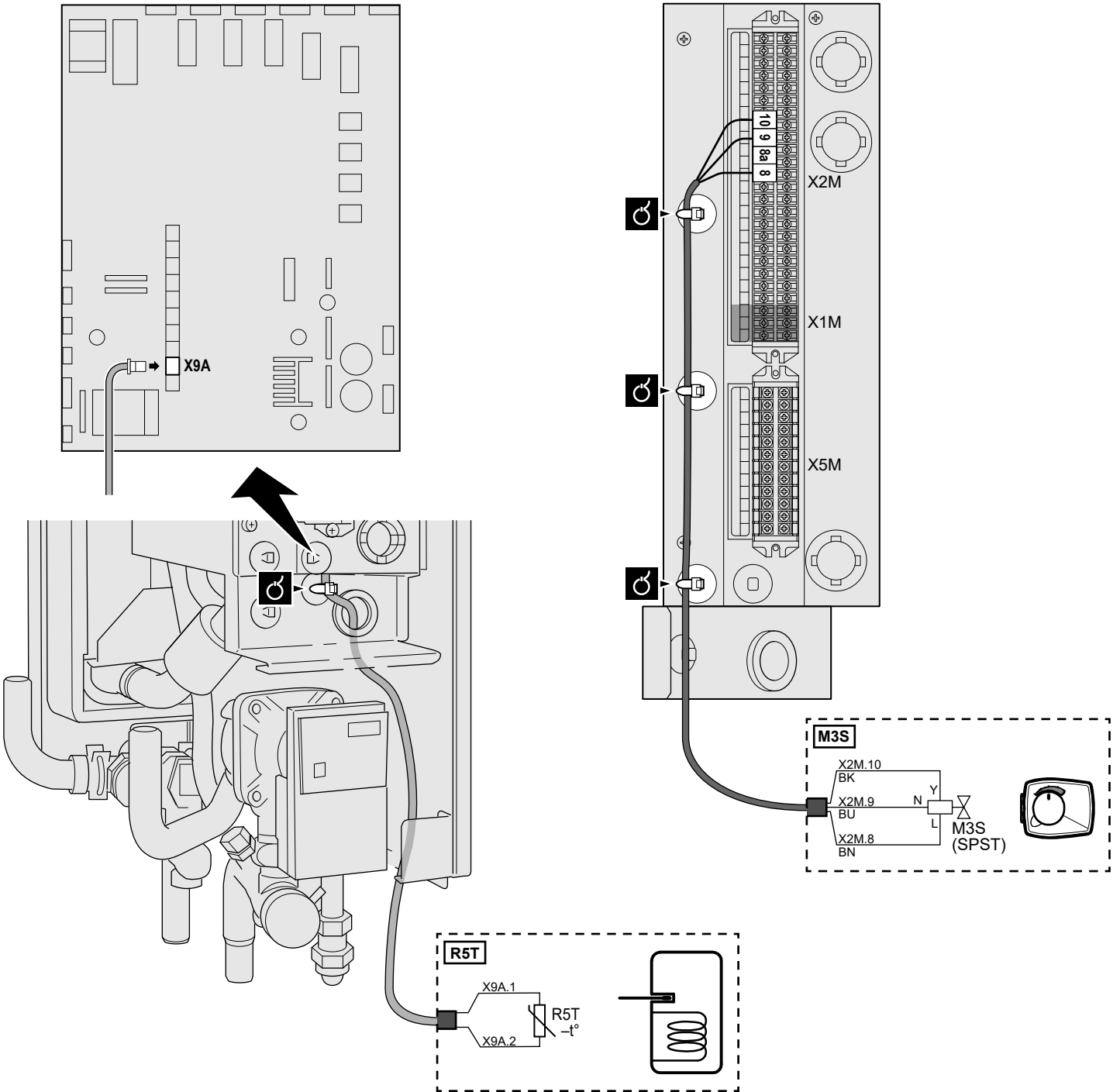

EHB(H/X)*(D/E)* + ETB(H/X)*(D/E)* + EAB(H/X)*D*

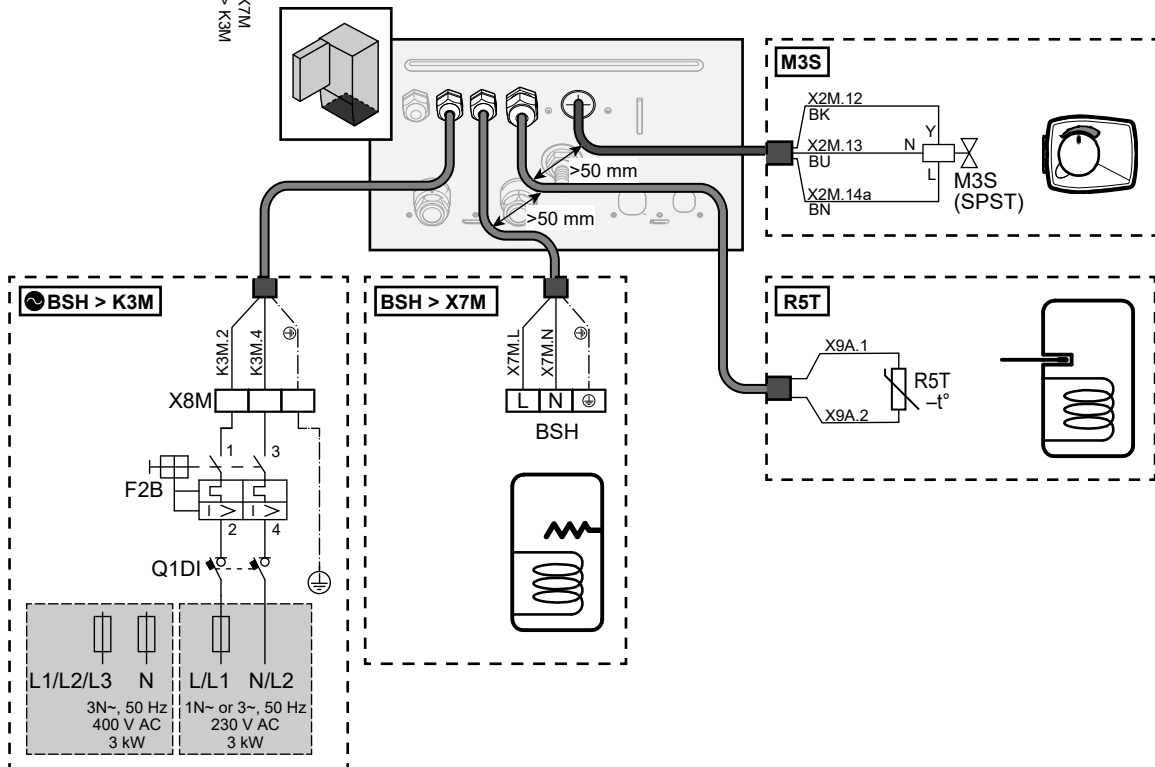
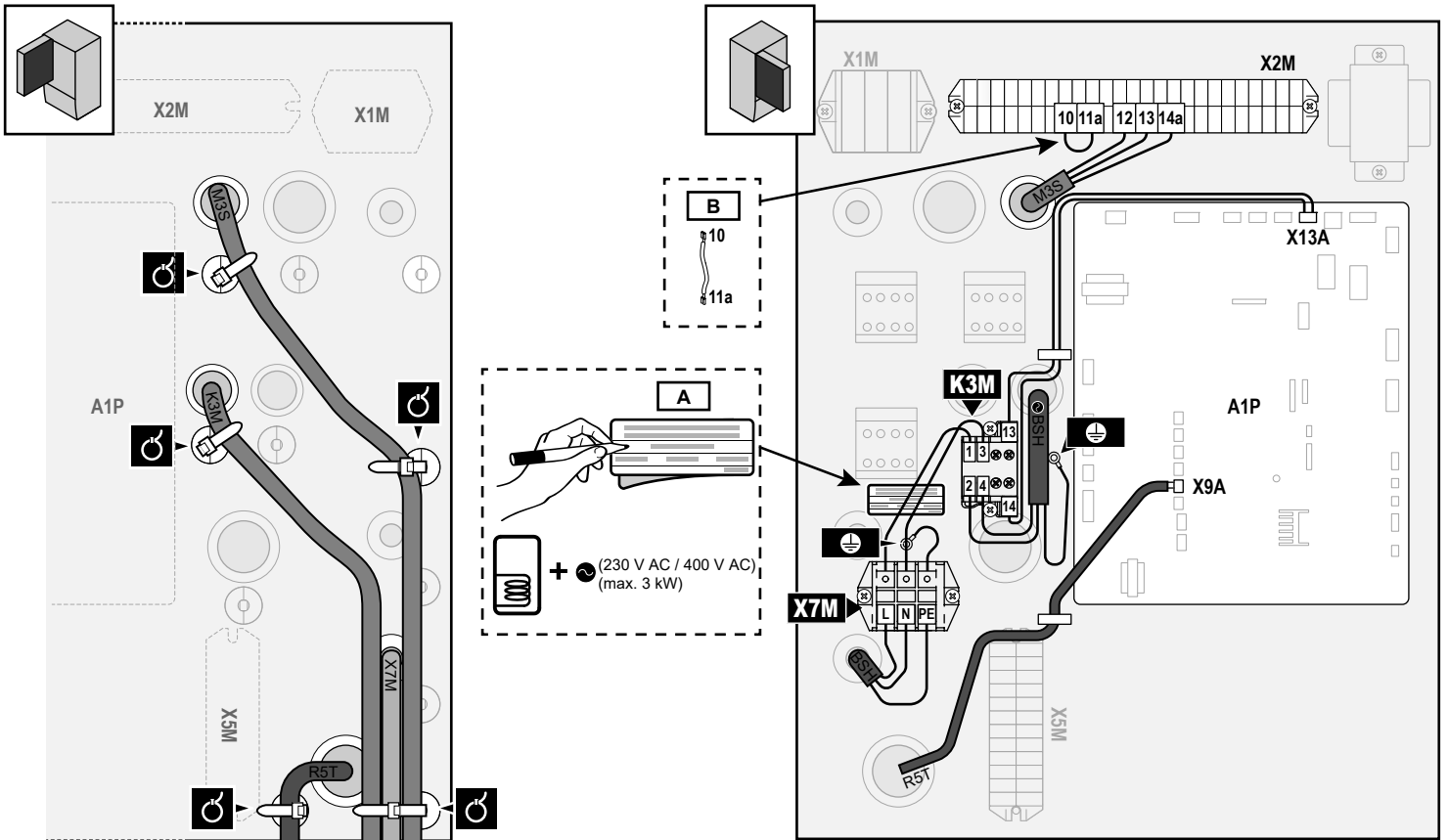

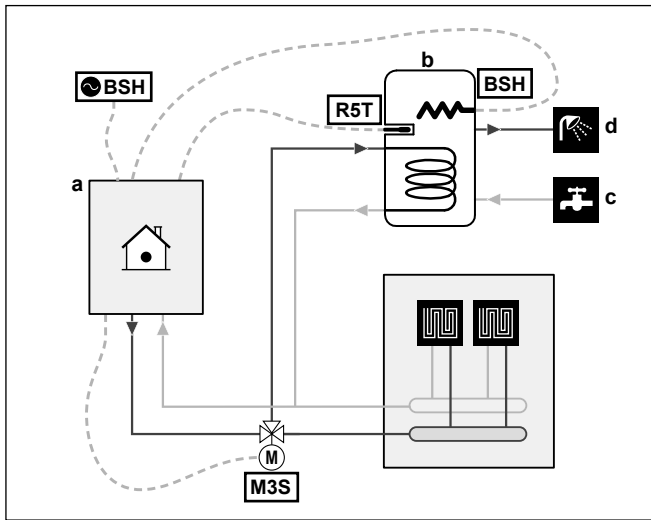

	a	b	c	d	M3S	R5T	BSH (☞)
GB	Indoor unit	DHW tank	Cold water IN	Hot water OUT	Motorised 3-way valve	Thermistor (tank)	Booster heater (Power supply)
D	Innengerät	Brauchwasserspeicher	Kaltwassereinfluss	Warmwasserauslass	Motorisiertes 3-Wege-Ventil	Thermistor (Speicher)	Zusatzheizung (Stromversorgung)
F	Unité intérieure	Ballon ECS	ENTRÉE d'eau froide	SORTIE d'eau chaude	Vanne 3 voies motorisée	Thermistance (réservoir)	Booster ECS (Alimentation électrique)
NL	Binnenunit	Warmtapwatertank	Koud water IN	Warm water UIT	Gemotoriseerde 3-wegklep	Thermistor (tank)	Boosterverwarming (Elektrische voeding)
I	Unità interna	Serbatoio ACS	Acqua fredda ENTRATA	Acqua calda USCITA	Valvola a 3 vie motorizzata	Termistore (serbatoio)	Surriscaldatore (Alimentazione elettrica)
DK	Indendørsenhed	DHW-tank	Koldt vand IND	Varmt vand UD	Motorrevet 3-vejsventil	Termomodstand (tank)	Hjælpevarmer (Strømforsyning)
S	Inomhusenhet	VVB-tank	Kallvatten IN	Varmvatten UT	Motorstyrd 3-vägsventil	Termistor (tank)	Elpatron tank (Strömförsörjning)
N	Innendørsenhed	Husholdningsvarmtvannstank	Kaldtvann INN	Varmtvann UT	Motorisert 3-veisventil	Termistor (tank)	Tilleggsvarmer VVB (Strømforsyning)
FIN	Sisäyksikkö	Kuumavesivaraaja	Kylmän veden TULO	Kuuman veden LÄHTÖ	Mootoroitu 3-tieventtiili	Termistori (säiliö)	Lisälämmitin (Virransyöttö)
TR	İç ünite	DHW boyleri	Soğuk su GİRİŞİ	Sıcak su ÇIKIŞI	Motorlu 3 yollu vana	Termistör (boyler)	Buster ısıtıcı (Güç kaynağı)
SLD	Notranja enota	Rezervoar za sanitarno toplo vodo	VHOD hladne vode	IZHOD tople vode	Motorizirani 3-potni ventil	Termistor (rezervoar)	Pospeševalni grelnik (Napajanje)
SK	Vnútroňá jednotka	Nádrž na teplú vodu pre domácnosť	PRÍVOD studenej vody	ODVOD teplej vody	3-cestný ventil so servomotorom	Termistor (nádrž)	Prídavný ohrievač (Elektrické napájanie)
RUS	Внутренний блок	Резервуар ГВБП	ВХОД холодной воды	ВЫХОД горячей воды	3-ходовой клапан с электроприводом	Термистор (резервуар)	Вспомогат.нагреватель (Электропитание)
RO	Unitatea interioara	Rezervor ACM	INTRARE apă rece	IEȘIRE apă caldă	Ventil cu 3 căi cu servomotor	Termistor (rezervor)	Încalzitor auxiliar (Alimentare cu energie electrică)
P	Unidade de interior	Depósito de AQS	ENTRADA de água fria	SAÍDA de água quente	Válvula de 3 vias motorizada	Termistor (depósito)	Resistência elétrica do depósito (Fonte de alimentação)
PL	Jednostka wewnętrzna	Zbiornik CWU	WLOT zimnej wody	WYLOT cieplej wody	Elektrozawór 3-drogowy	Termistor (zbiornik)	Grzałka BSH (Przewód zasilania)
LV	Iekštelpu iekārta	Karstā ūdens tvertne	Aukstā ūdens IEVADE	Karstā ūdens IZVADE	Motorizēts trīsvirzienu vārsts	Termistors (tvertne)	Palīgildītājs (Strāvas padeve)
LT	Patalpose naudojamas įrenginys	BKV katilas	Šalto vandens ĮLEIDIMAS	Karšto vandens IŠLEIDIMAS	3-eigis vožtuvas su varikliu	Termistorius (katilas)	Startinis šildytuvas (Maitinimo šaltinis)
H	Beltéri egység	Használatimelegvív-tartály	Hidegvíz BE	Melegvív KI	Motoros 3 utas szelep	Hőmérséklet-érzékelő (tartály)	Segédfűtőelem (Tápellátás)
HR	Unutarnja jedinica	Spremnik KVV-a	ULAZ hladne vode	IZLAZ vruće vode	3-putni motorni ventil	Termistor (spremnik)	Dodatni grijač (Napajanje)
E	Unidad interior	Depósito de ACS	ENTRADA de agua fría	SALIDA de agua caliente	Válvula de 3 vias motorizada	Termistor (depósito)	Resistencia de refuerzo (Suministro eléctrico)
GR	Εσωτερική μονάδα	Δοχείο ZNX	ΕΙΣΟΔΟΣ κρύου νερού	ΕΞΟΔΟΣ ζεστού νερού	Μηχανοκίνητη 3οδη βάνα	Θερμίστορ (δοχείο ZNX)	Αντίσταση δοχείου (Τροφοδοσία)
CZ	Vnitřní jednotka	Nádrž TUV	VSTUP studené vody	VÝSTUP teplé vody	Motorem ovládaný 3cestný ventil	Termistor (nádrž)	Přídavný ohřivač (Napájení)
BG	Вътрешно тяло	Бойлер за БГВ	Студена вода ВХОД	Гореща вода ИЗХОД	Моторизиран 3-пътен вентил	Термистор (бойлер)	Допълнителен нагревател (Захранване)
UA	Внутрішній блок	Бак ГВПП	ВХІД холодної води	ВИХІД гарячої води	Моторизований 3-ходовий клапан	Термістор (бак)	Допоміжний нагрівач (Електроживлення)
EST	Siseseade	Sooja tarvevee paak	Külm vesi SISSE	Soe vesi VÄLJA	Motoriseeritud 3-suunaline klapp	Termistor (paak)	Lisakütteaseade (Toiteallikas)